

- Wide Frequency Range 10 MHz to 8 GHz
- High Performance Solid State Switch
- 8:1 or 16:1 Multiplexer Versions
- Automatic Termination of Unused MUX Channels
- +30 dBm Input Power Handling
- Excellent Crosstalk & Isolation
- SMA Coaxial Connectors
- VISA, IVI & Kernel Drivers Supplied for Windows
- Supported by PXI or LXI Chassis
- 3 Year Warranty

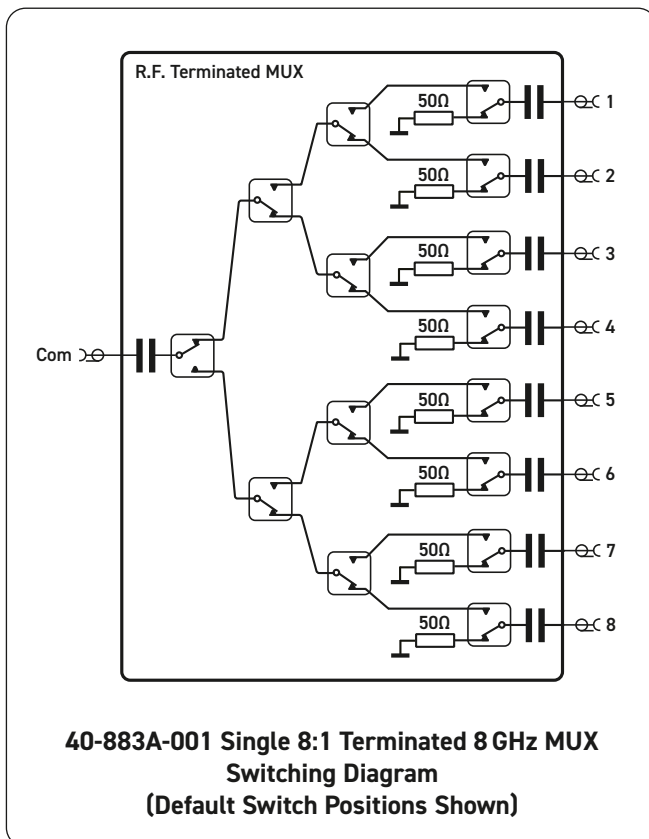

The 40-883A is a 50 Ω 8 GHz multiplexer which can operate to frequencies beyond 8GHz. It is available in 8:1 format in a two slot PXI module or 16:1 format in a three slot PXI module.



The 40-883A exhibits low VSWR over the full operating frequency range and consistent and flat insertion loss characteristics. The use of solid state switches ensure a long service life with no wear out mechanism, making the 40-883A ideal for ATE systems requiring frequent and fast operating RF switching. The 40-883A can handle RF input powers of up to +30 dBm and is able to sustain frequent hot switching without performance degradation.

The module is fitted with SMA connectors, ensuring module compatibility with commonly used cables.

The 40-883A is supplied with drivers that allow users to support the module in all popular PXI software environments. In addition the 40-883A can be supported in Pickering Interfaces 60-100 series LXI Modular Switching chassis, permitting users to choose their switching platform with the same high performance characteristics and driver environment.



40-883A-002 16:1 Terminated 8 GHz MUX

Typical RF Performance Plots For 8:1 Multiplexer

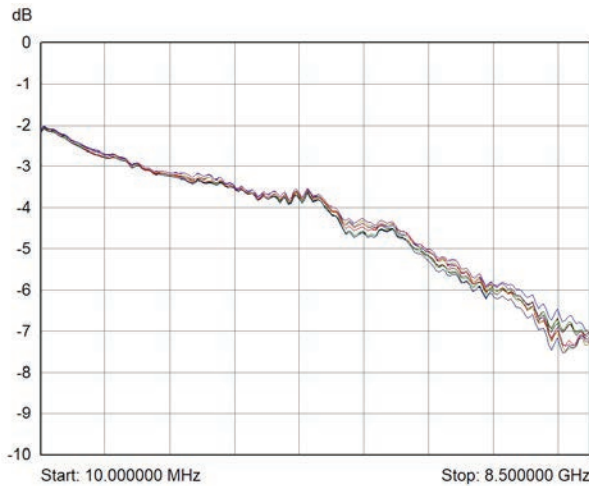

Insertion loss for 40-883A-001 showing all paths up to 8.5 GHz

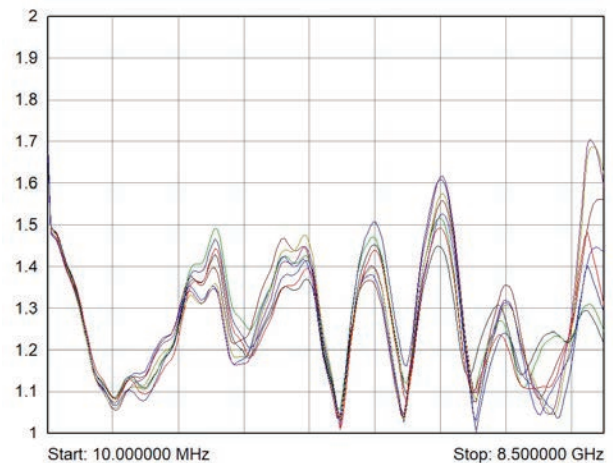

VSWR Channel to COM for 40-883A-001 showing all paths up to 8.5 GHz

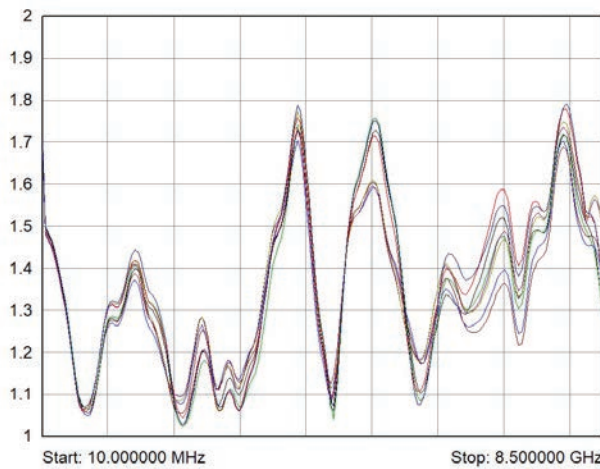

VSWR COM to Channel for 40-883A-001 showing all paths up to 8.5 GHz

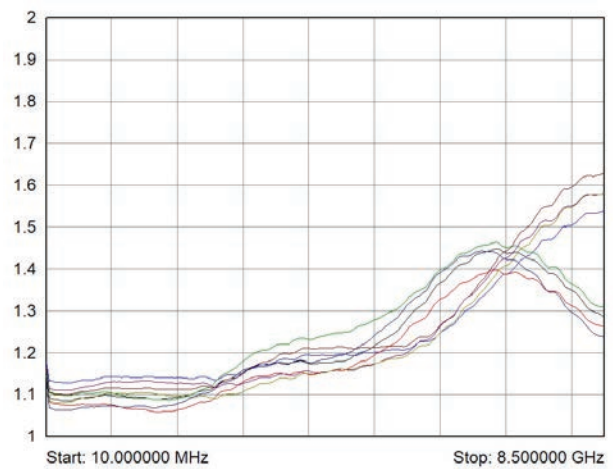

VSWR internal termination on channel for 40-883A-001 showing all paths up to 8.5 GHz

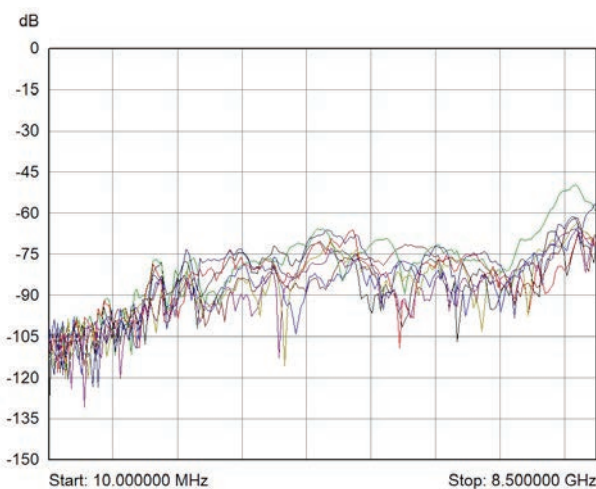

Max isolation for each channel with distant path selected for 40-883A-001 up to 8.5 GHz

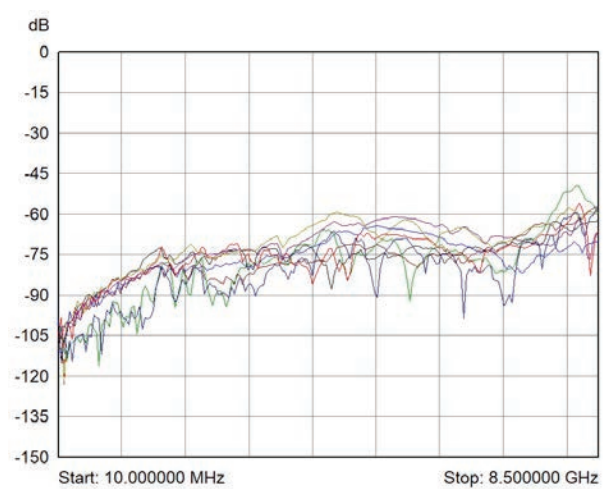

Crosstalk for 40-883A-001 between adjacent channels showing all paths up to 8.5 GHz

Typical RF Performance Plots For 16:1 Multiplexer

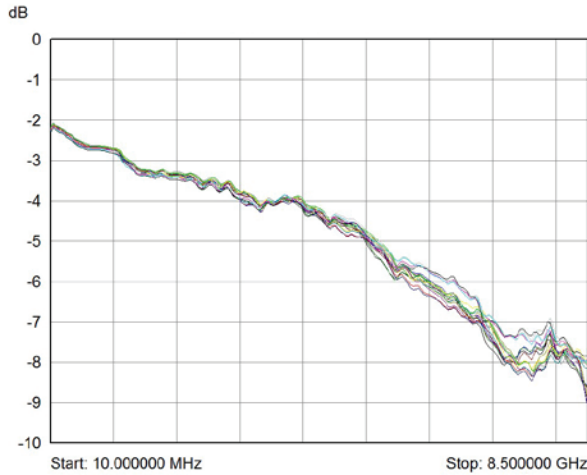

Insertion loss for 40-883A-002 showing all paths up to 8.5 GHz

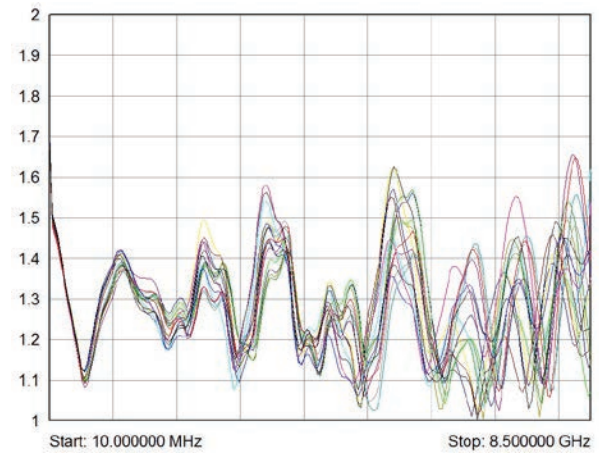

VSWR Channel to COM for 40-883A-002 showing all paths up to 8.5 GHz

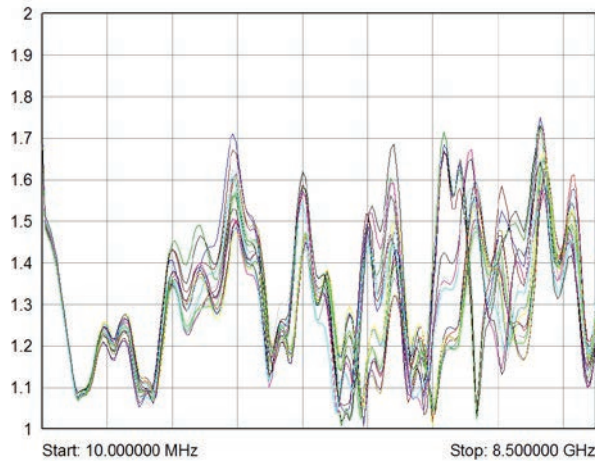

VSWR COM to Channel for 40-883A-002 showing all paths up to 8.5 GHz

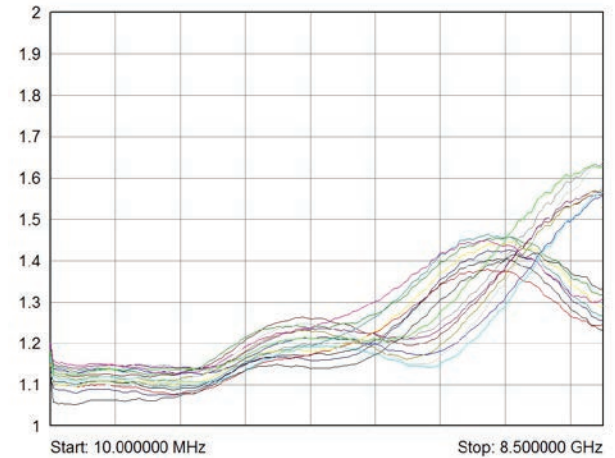

VSWR internal termination on channel for 40-883A-002 showing all paths up to 8.5 GHz

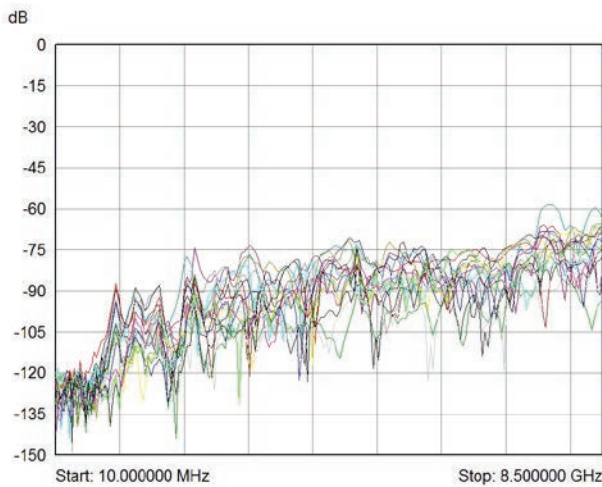

Max isolation for each channel with distant path selected for 40-883A-002 up to 8.5 GHz

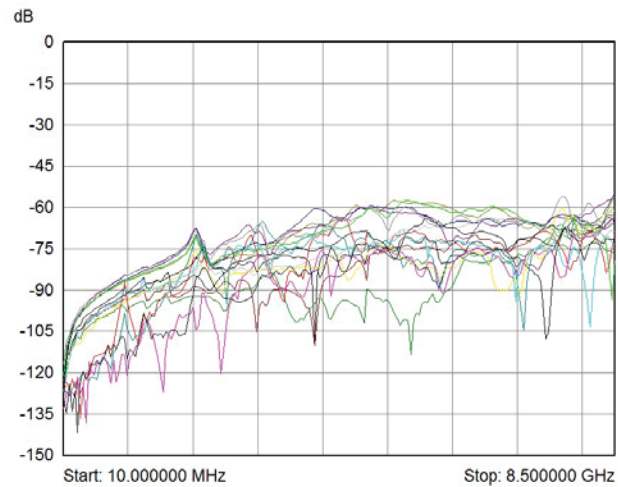

Crosstalk for 40-883A-002 between adjacent channels showing all paths up to 8.5 GHz

General Specification

Characteristic Impedance:	50 Ω
Maximum RF Power:	+30 dBm CW +20 dBm Hot switching +26 dBm Into terminations
Maximum DC Voltage:	7 V (AC coupled)
Life Expectancy:	Indefinite when used within ratings
Operate Time:	50 μs
RF Switching Time:	10 μs typical rise and fall time
RF Connectors:	SMA

RF Specification - 8:1 MUX (40-833A-001)

RF Frequency Range:	10 MHz to 8 GHz
Insertion Loss:	typically <2.5 dB @10 MHz typically <4 dB to 3 GHz typically <6 dB to 6 GHz typically <8 dB to 8 GHz
VSWR CH-COM:	typically <1.65:1 to 8 GHz
VSWR COM-CH:	typically <1.55:1 to 3 GHz typically <1.85:1 to 8 GHz
VSWR termination:	typically <1.5:1 to 6 GHz typically <1.7:1 to 8 GHz
Isolation:	typically >60 dB to 7 GHz typically >50 dB to 8 GHz
Crosstalk	typically <-55 dB to 7 GHz typically <-50 dB to 8 GHz

RF Specification - 16:1 MUX (40-883A-002)

RF Frequency Range:	10 MHz to 8 GHz
Insertion Loss:	typically <2.5 dB @ 10 MHz typically <4 dB to 3 GHz typically <6.5 dB to 6 GHz typically <9 dB to 8 GHz
VSWR CH-COM:	typically <1.6:1 to 5 GHz typically < 1.7:1 to 8 GHz
VSWR COM-CH:	typically <1.75:1 to 8 GHz
VSWR termination:	typically <1.5:1 to 6 GHz typically < 1.7:1 to 8 GHz
Isolation:	typically >65 dB to 7 GHz typically >55 dB to 8 GHz
Crosstalk	typically <-65 dB to 7 GHz typically <-55 dB to 8 GHz

Power Requirements

+3.3 V	+5 V	+12 V	-12 V
30 mA	100 mA	0	0

Mechanical Characteristics

- Single 8:1 version: 2 slot 3U PXI module (40-883A-001)
 - Single 16:1 version: 3 slot 3U PXI module (40-883A-002)
- 3D models for all versions in a variety of popular file formats are available on request.

Connectors

PXI bus via 32-bit P1/J1 backplane connector.
Signals via front panel SMA connectors.

Operating/Storage Conditions

Operating Conditions

Operating Temperature: 0°C to +55°C
Humidity: Up to 90% non-condensing
Altitude: 5000 m

Storage and Transport Conditions

Storage Temperature: -20°C to +75°C
Humidity: Up to 90% non-condensing
Altitude: 15000 m

PXI & CompactPCI Compliance

The module is compliant with the PXI Specification 2.2. Local Bus, Trigger Bus and Star Trigger are not implemented.

Uses a 33 MHz 32-bit backplane interface.

Safety & CE Compliance

All modules are fully CE compliant and meet applicable EU directives: Low-voltage safety EN61010-1:2001, EMC Immunity EN61000-6-1:2001, Emissions EN55011:1998.

Product Order Codes

Single 8:1 8 GHz MUX, SMA, Terminated 40-883A-001
 Single 16:1 8 GHz MUX, SMA, Terminated 40-883A-002

Product Customization

Pickering modules are designed and manufactured on our own flexible manufacturing lines, giving complete product control and enabling simple customization to meet very specific requirements.

All customized products are given a unique part number, fully documented and may be ordered at any time in the future. Please contact your local sales office to discuss.

Mating Connectors & Cabling

For connection accessories for the 40-883A module please refer to the [90-011D](#) RF Cable Assemblies data sheet where a complete list and documentation can be found for accessories, or refer to the Connection Solutions catalog.

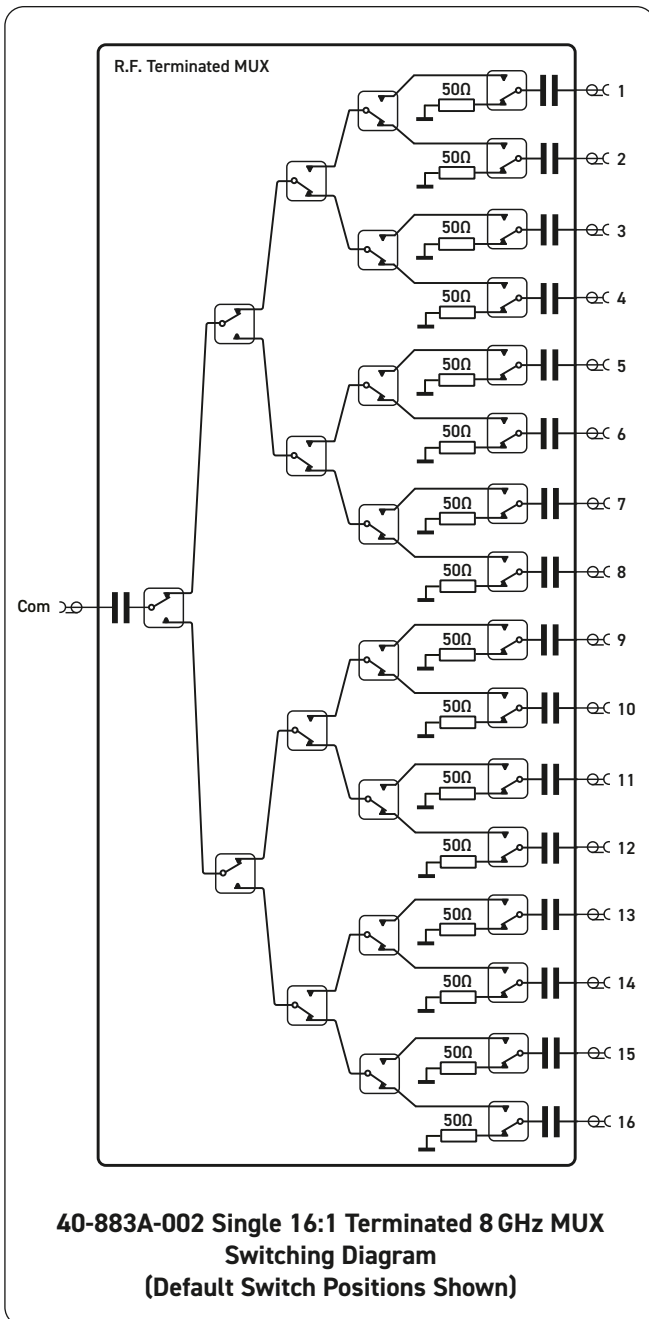

Chassis Compatibility

This PXI module must be used in a suitable chassis. It is compatible with the following chassis types:

- All chassis conforming to the 3U PXI and 3U Compact PCI (cPCI) specification
- Legacy and Hybrid Peripheral slots in a 3U PXI Express (PXIe) chassis
- Pickering Interfaces LXI or LXI/USB Modular Chassis

Chassis Selection Guide

Standard PXI or hybrid PXIe Chassis from any Vendor:

- Mix our 1000+ PXI switching & simulation modules with any vendor's PXI instrumentation
- Embedded or remote Windows PC control
- Real-time Operating System Support
- High data bandwidths, especially with PXI Express
- Integrated module timing and synchronization



Pickering LXI or LXI/USB Modular Chassis—only accept our 1000+ PXI Switching & Simulation Modules:

- Ethernet or USB control enables remote operation
- Low-cost control from practically any controller
- LXI provides manual control via Web browsers
- Driverless software support
- Power sequencing immunity
- Ethernet provides chassis/controller voltage isolation
- Independence from Windows operating system



Connectivity Solutions

We provide a full range of supporting cable and connector solutions for all our switching products—20 connector families with 1200+ products. We offer everything from simple mating connectors to complex cables assemblies and terminal blocks. All assemblies are manufactured by Pickering and are guaranteed to mechanically and electrically mate to our modules.



Connectors & Backshells



Multiwire Cable Assemblies

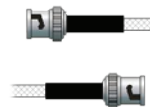

RF Cable Assemblies



Connector Blocks

We also offer customized cabling and have a free online **Cable Design Tool** that can be used to create custom cable solutions for many applications. Visit: pickeringtest.com/cdt to start your design.

Mass Interconnect

We recommend the use of a mass interconnect solution when an Interchangeable Test Adapter (ITA) is required for a PXI or LXI based test system. Our modules are fully supported by both Virginia Panel and MacPanel.



Pickering Reed Relays

We are the only switch provider with in-house reed relay manufacturing capability via our Relay Division. These instrument grade reed relays feature **SoftCenter™** technology, ensuring long service life and repeatable contact performance. To learn more, please go to: pickeringrelay.com



Programming

Pickering provide kernel, IVI and VISA (NI & Keysight) drivers which are compatible with all Microsoft supported versions of Windows and popular older versions. For a list of all supporting operating systems, please see: pickeringtest.com/os

The VISA driver is also compatible with Real-Time Operating Systems such as LabVIEW RT. For other RTOS support contact Pickering. These drivers may be used with a variety of programming environments and applications including:

- **Pickering Interfaces Switch Path Manager**
- **National Instruments** products (LabVIEW, LabWindows/CVI, Switch Executive, MAX, TestStand, VeriStand, etc.)
- **Microsoft Visual Studio** products (Visual Basic, Visual C+)
- **Keysight** VEE and OpenTAP
- **Mathworks** Matlab
- **Marvin** ATEasy
- **MTQ Testsolutions** Tecap Test & Measurement Suite

Drivers for popular Linux distributions are available, other environments are also supported, please contact Pickering with specific enquiries. We provide Soft Front Panels (SFPs) for our products for familiarity and manual control, as well as comprehensive documentation and example programs to help you develop test routines with ease.

To learn more about software drivers and development environments, please go to: pickeringtest.com/software

Signal Routing Software

Our signal routing software, Switch Path Manager, automatically selects and energizes switch paths through Pickering switching systems. Signal routing is performed by simply defining test system endpoints to be connected together, greatly accelerating Test System software development. To learn more, please go to: pickeringtest.com/spm

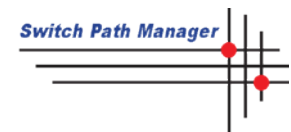

Diagnostic Relay Test Tools

eBIRST Switching System Test Tools are designed specifically for our PXI, PCI or LXI products, these tools simplify switching system fault-finding by quickly testing the system and graphically identifying the faulty relay.

To learn more, please go to: pickeringtest.com/ebirst



Three Year Warranty & Guaranteed Long-Term Support

All standard products manufactured by Pickering Interfaces are warranted against defective materials and workmanship for a period of three years from the date of delivery to the original purchaser. Extended warranty and service agreements are available for all our modules and systems with various levels to suit your requirements. Although we offer a 3-year warranty as standard, we also include guaranteed long-term support—with a history of supporting our products for typically 15-20 years. To learn more, please go to: pickeringtest.com/support

Available Product Resources

We have a large library of product resources including success stories, product and support videos, articles and white papers as well as application specific product brochures to assist when looking for the switching, simulation and connection solutions you need. We have also published handy reference books on Switching Technology and for the PXI and LXI standards.



To view, download or request any of our product resources, please visit: pickeringtest.com/resources