

- Modular Matrix Design With 32 Y Axis Connections
- User Configurable for X Dimensions by Plug-in addition, up to 192x32
- Single Analog Bus
- Switch up to 1 A
- Uses High Quality Pickering Ruthenium Reed Relays
- Built-In Scan List Sequence Stores With Triggering Capability
- Supported by **BIRST™** & **eBIRST™** Test Tools
- Fully Compliant to 1.5 LXI Standard
- 3 Year Warranty



The 65-227 is a modular matrix platform that provides a large reed relay matrix solution with 1 A current carrying capacity on all Y paths.

Matrices are created by populating a 65-200 chassis with plug-in modules that provide access to the X and Y axis on 200-pin LFH connectors. The chassis is capable of supporting matrices with a Y size of 32 and X sizes up to 192 in increments of 32. Users can specify as many or as few plug-in modules as they require and can field upgrade the chassis to extend the matrix.

The chassis supports up to 6 plug-in modules. These can be with or without direct Y bus access and are loaded into the chassis via the front panel, greatly improving flexibility and ease of maintenance.

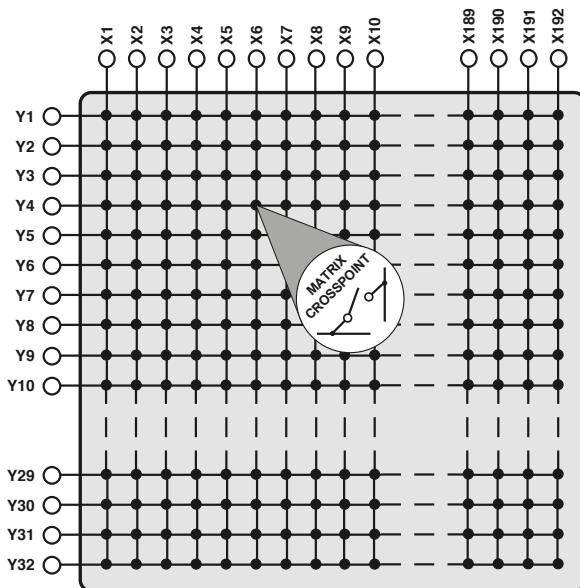

Simplified Diagram For 65-227 Configured as a 192x32 Matrix

Analog Buses

Each plug-in is a single 32x32 sub-matrix with the ability to connect its Y axis to an analog bus. This can be used to maximize bandwidth by disconnecting unused stub matrices from the bus in use, or can be used to produce single or independent matrices whose size can be set by the user in increments of 32 X connections.

Cooling for the 65-200 is provided by rear fans and front air intakes ensuring no wasted space when the chassis is rack mounted. The cooling system is adaptive, ensuring the acoustic noise is minimised when used in quiet laboratory environments and low load conditions.

Configuring the Matrix

To select the parts that you need to create a matrix simply:

- Specify a 65-200-002 Modular Matrix Chassis.
- Add Matrix Plug-in Modules with direct Y access as required.
- Add Matrix Plug-in Modules without direct Y access as required.

Both styles of plug-in module have a single 32x32 matrix, with a single analog bus.

Built-In Relay Self-Test - BIRST

The **BIRST** facility provides a quick and simple way of finding relay failures. No test equipment is required, simply un-plug the user connectors, launch the **BIRST** application and the tool will run a diagnostic test that will find all relays with faulty contacts.

For more information go to: pickeringtest.com/birst

Supported by eBIRST

The matrix is also supported by our **eBIRST** test tools. These simplify switching fault-finding by quickly testing the system and graphically identifying the faulty relay.

For more information go to: pickeringtest.com/ebirst

Pickering's Range of LXI Modular Reed Relay Matrices			
Y-Axis	X Range	Analog Buses	Model No.
4	128 to 1536	12 or 6	65-221
8	64 to 768	6	65-223
16	32 to 384	3	65-225
32	32 to 192	1	65-227

Front Panel Connector

This product is based on the obsolete Molex LFH series connector that has been superseded by a Pickering commissioned form, fit, function equivalent. The new connector series is 100% compatible with the Molex connectors allowing either gender of Pickering connector to mate with the corresponding Molex part without issue.

65-227 matrix configurations range between 32x32 and 192x32. The overall matrix size can be altered by the addition or removal of plug-in modules.

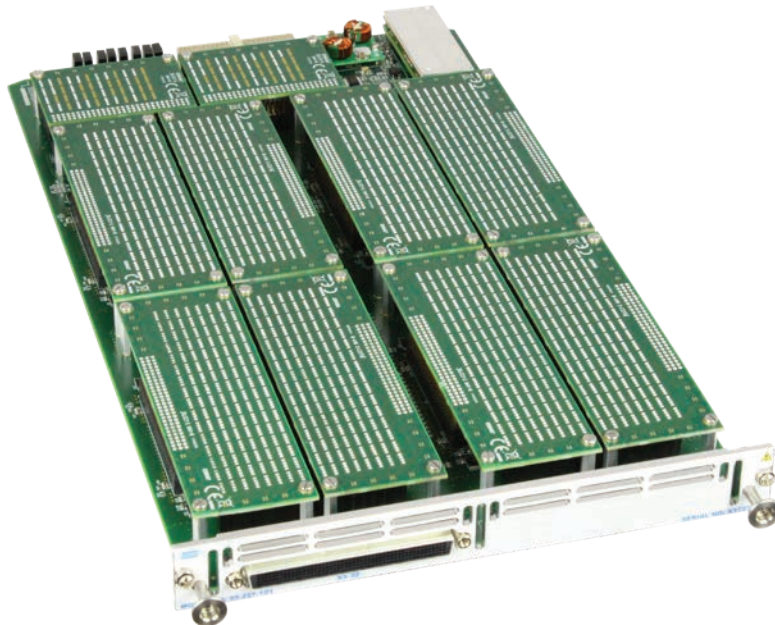

The 65-227 plug-in modules are supplied as a single 32x32 matrix with or without front panel access to the Y-bus. Also, an analog bus is provided with 32 connections which can be routed via isolation relays to the Y-bus of any 32x32 sub-matrix that makes up the overall 65-227 matrix.

The 32x32 matrices of the 65-227 plug-in modules are made up from eight 32x4 matrix plug-on modules. These use Pickering high density instrument grade ruthenium reed relays for maximum reliability and performance. The isolation relays that connect the analog bus to the matrix are also on replaceable plug-on modules.

The modular architecture of the 65-227 allows easy maintenance and repair.

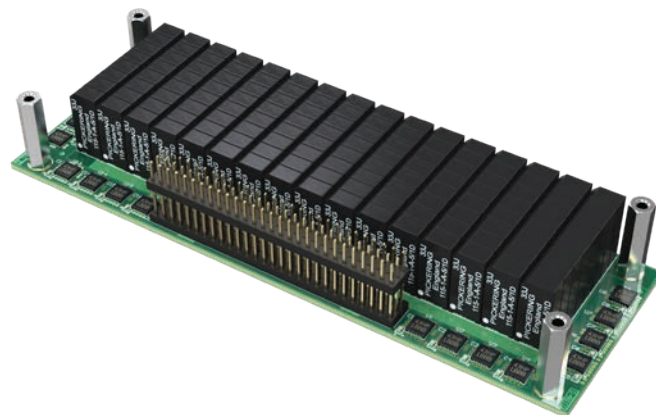

Example Configuration

2 U 192x32 Matrix With 1 Analog Bus

Matrix that permits 32 concurrent connections to be made between Y and X or X and X with Y access when utilising the analog bus capability.

- 1 off 65-200-002 2 U Modular Matrix Chassis
- 1 off 65-227-001 Matrix Plug-in, direct Y access, 1 analog bus
- 5 off 65-227-101 Matrix Plug-in, no direct Y access, 1 analog bus

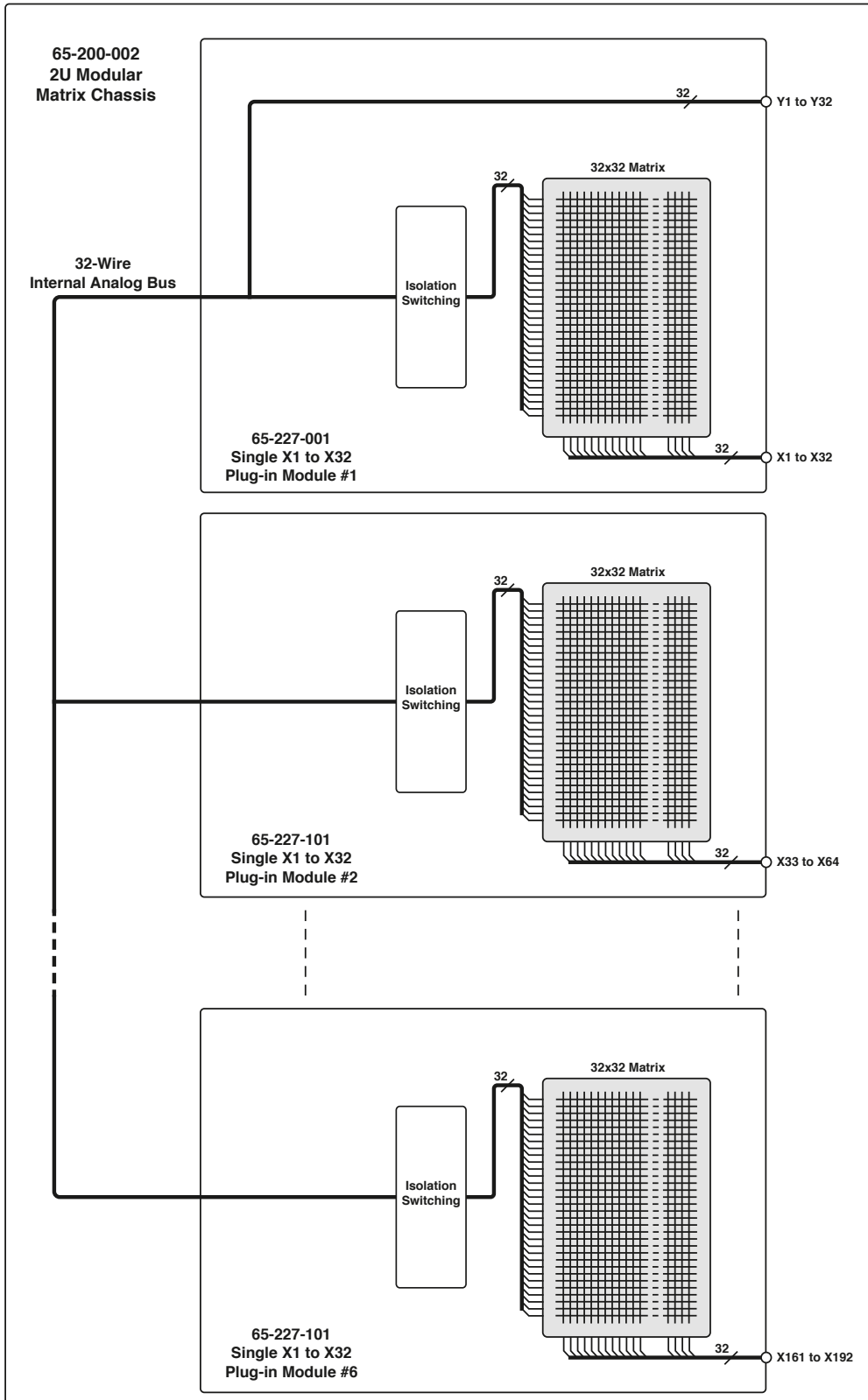

65-227 Configured as a 192x32 matrix with 1 analog bus using:

- 65-200-002 2 U Modular Matrix Chassis
- 1 off 65-227-001 Plug-in Modules
- 5 off 65-227-101 Plug-in Modules

Sequencing Service and Triggering

The Sequencing service provides the user with the ability to set a series of pre-determined sequences on an LXI instrument. These sequences can be triggered by software or one of the sixteen software configurable open collector triggers.

As the operations are grouped together, it will minimize the number of control transactions required to achieve a composite change of target switch state, condensing multiple operations in a single sub unit into a single operation, thus reducing the overall system switch settling time.

For example, if a user wants to operate X1-Y1, X4-Y1, X2-Y2, in the first sequence, only one operation, and so delay, will be used.

Additionally, as the switch state sequences are stored within the LXI controller itself, the burden on the Host CPU and Ethernet traffic is greatly reduced, and so the overall system latency is also reduced.

This unit features a software reset line which provides the ability for a user supplied reset to be applied to the unit, triggering a software reset of the relays, returning all relays in the unit to their default state. There is also a software fault line available that will be triggered if there is any error detected within the unit. Please note that while these reset and fault lines use dedicated physical connections to the unit, they are software control lines and as such should not be used for safety interlocks etc.

Speed of Operation

Speed of Operation can be important when defining systems for test applications, therefore it can be beneficial to understand all the necessary overhead delays associated with a switch operation.

If we consider a single relay / block relay operation, it can be considered to be a combination of five discrete operations: PC Processing, Ethernet Latency, LXI Processing / Virtualisation, Serial Loop Transmission and Relay Settling.

A representation of these processes can be seen in the diagram below.

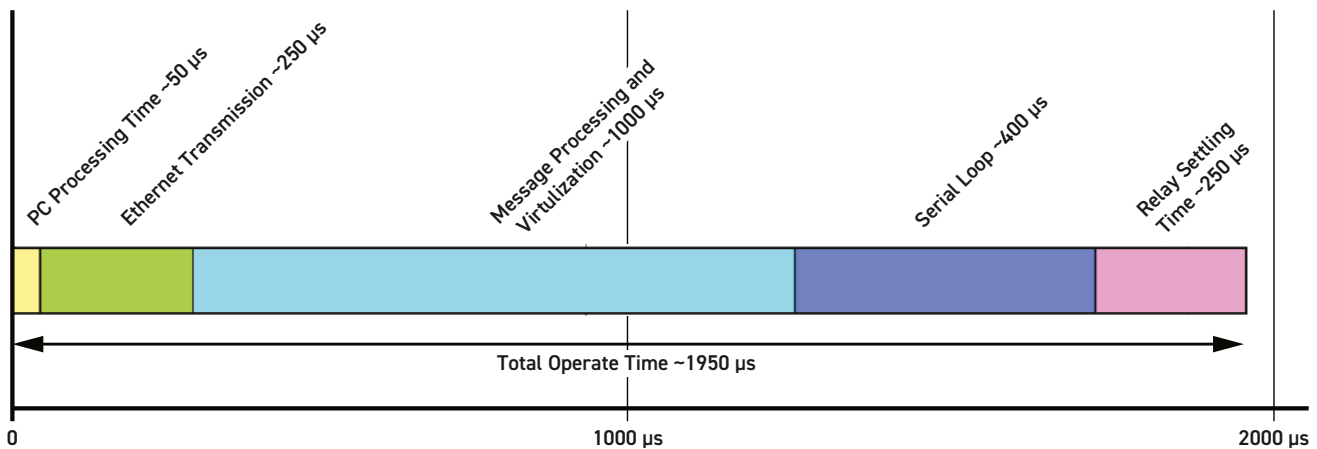

Speed of Operation Diagram For The 65-227

Note: These are estimated figures, PC processing and Ethernet transmission times may vary depending upon the overall system setup and load.

Matrix Specification

General:	Provides 32 concurrent X to Y or X to X connections.
Maximum Size:	192x32 using 65-200-002
Maximum Hot Switching Capacity	
Maximum Switch Current:	1 A
Maximum Switch Voltage:	150 VDC/100 VAC*
Maximum Power:	20 W/20 VA
Relay Type:	Pickering Reed Relay (Ruthenium Sputtered)
Estimated Plug-in Setting Time:	<2 ms (per relay or relay block operation) Note: This figure may vary depending upon user setup and network load.
Initial Path Resistance - On:	Plug-in: <1.3 Ω (1.1 Ω typical) System†: <1.9 Ω (1.4 Ω typical)
Initial Path Resistance - Off:	>10 ⁹ Ω
Thermal Offset:	40 μV (typical)
Crosspoint Closure Limit:	378†
† This represents an example system configured as a 192x32 matrix consisting of 1x 65-227-001 & 5x 65-227-101 Plugin Modules housed within an 65-200-002 Chassis.	
Expected Life (operations):	>1x10 ⁹ (Low Load) >1x10 ⁶ (Full Load)

* For full voltage rating, signal sources to be switched must be fully isolated from mains supply and safety earth.

RF Specification (Measurement at Front Panel)

Bandwidth (-3 dB):	Plug-in: 8.5 MHz (typical) System: 7 MHz (typical)
Bandwidth (1.5:1 VSWR):	Plug-in: 1.7 MHz (typical)
Crosstalk (typical):	10 kHz: -60 dB (typical) 100 kHz: -45 dB (typical) 1 MHz: -25 dB (typical) 10 MHz: -5d B (typical)
Isolation (typical):	10 kHz: 65 dB (typical) 100 kHz: 55 dB (typical) 1 MHz: 35 dB (typical) 10 MHz: 10 dB (typical)

Safety & CE Compliance

All products are fully CE compliant and meet applicable EU directives:

Low-voltage safety EN61010-1:2010,

EMC Immunity EN61326-1:2013,

Emissions EN55011:2009+A1:2010.

Mechanical Specification

Chassis Dimensions:	2 U rack mountable full width, depth 500 mm.
Number of Plug-ins Supported:	6 (in 65-200-002 chassis)
Plug-in Connectors:	200-pin LFH* socket for 32x32 plug-in modules.
Trigger Connector:	25-pin male micro D-type
Chassis Cooling:	Front air intakes through plug-in module holes, temperature controlled speed adjustable fans.

* LFH relates to the obsolete Molex connector series and is retained for continuity, products will be fitted with a form, fit, function Pickering equivalent connector that is intermateable with the original Molex parts.

Power Source

Universal AC mains supply, 90-120/200-240 V 50-60 Hz.

Power Inlet: Male IEC connector

Power Rating: 100 VA maximum

Fuse Rating: (F) 5 A 250 V

LAN Interface

1000Base-T Ethernet Interface with a standard RJ-45 connector mounted on the rear panel. Compliant to LXI Standard 1.5

Triggering

- 16x Software Configurable Bidirectional Open Collector Triggers
- 1x Dedicated Software Reset Line
- 1x Dedicated Software Fault Line
- 1x Dedicated Interlock Line

Scan List Sequencing

Capable of storing 5000 predefined test sequences, loaded from the host Controller to the LXI unit at process initialization, with the ability to be triggered through software or from any of the sixteen software configurable triggers. For more information on the Pickering Sequence Manager, please go to: [pickering-sequence-manager](#)

Operating/Storage Conditions

Operating Conditions

Operating Temperature: 0°C to +55°C

Humidity: Up to 90% non-condensing

Altitude: 5000 m

Storage and Transport Conditions

Storage Temperature: -20°C to +75°C

Humidity: Up to 90% non-condensing

Altitude: 15000 m

Product Order Codes

Specify which modules are required to build the matrix, Pickering Interfaces will supply the chassis with the modules installed if ordered at the same time. Plug-in modules can be ordered for chassis already supplied.

Chassis

2U Modular Matrix Chassis, 6-Slot **65-200-002**

Matrix Plug-in Modules

Single 32x32, direct Y access, 1 analog bus **65-227-001**

Single 32x32, no direct Y access, 1 analog bus **65-227-101**

Replacement Plug-on Modules

32x4 Matrix Plug-on **69-221-001**

Analog Bus Isolation Plug-on **69-221-002**

Product Customization

Pickering LXI units are designed and manufactured on our own flexible manufacturing lines, giving complete product control and enabling simple customization to meet very specific requirements.

Customization can include:

- Alternative reed relay types
- Mixture of reed relay types
- Alternative number of relays
- Different performance specifications

All customized products are given a unique part number, fully documented and may be ordered at any time in the future. Please contact your local sales office to discuss.

Support Products

eBIRST Switching System Test Tool

This product is supported by the eBIRST test tools which simplify the identification of failed relays, the required eBIRST tools are below. This product requires master slave testing and one set of each tool is required together with the master slave cable **93-970-301**.

For more information go to: pickeringtest.com/ebirst

Product	Test Tool	Adaptor	Termination
All Types	93-002-001	Not Required	93-002-101



To use eBIRST the test tool is fitted to the user connectors of the 65-227 plugin module. The supplied software is executed to perform a full diagnostic test of signal paths through the matrix. This will highlight failed or problem relays on a graphical interface.

Spare Relay Kits

Kits of replacement relays are available for the majority of our switching products, simplifying servicing and reducing down-time.

Product	Relay Kit
65-227-XXX	91-100-097

For further assistance, please contact your Pickering sales office.

Mating Connectors & Cabling

For connection accessories for the 65-227 series please refer to the [90-002D](#) 200-pin LFH Connector Accessories data sheet where a complete list and documentation can be found for accessories, or refer to the Connection Solutions catalog.



Pickering can supply mating 200-pin connectors and cable assemblies to enable easy integration of the 65-227 series of matrix plug-in modules

Pickering State-Of-The-Art Reed Relays

This matrix is constructed using very high density reed relays manufactured by our Relay Division.

Sputtered Ruthenium

Reed Relays

offer maximum performance, they are hermetically sealed and offer a very stable, long life relay contact (typically 10^9 operations) with very fast operate time.

Alternative types

such as electro-mechanical armature relays or non-instrumentation grade reed relays are lower cost but do not offer the consistent contact resistance, long life, fast switching speed and low level switching capability of a reed relay.

All of the reed relays used in our matrix switching modules are manufactured by our Relay Division, these offer maximum switching performance. Please visit the Reed Relay web site at pickeringrelay.com for further information.



Available from Pickering are the 60-102B and 60-103B LXI Modular Chassis. These are 7 and 18 slot chassis capable of hosting any of our range of PXI switching and programmable resistor modules under LXI control via a Gigabit Ethernet interface. Also available are the 60-104, 60-105 and 60-106. These are 2, 4 and 6 slot LXI/USB Modular Chassis which allow control of our PXI modules via Ethernet or USB.



The 65-227 range is part of a growing family of Scalable Matrix systems available from Pickering Interfaces. Illustrated is the LXI 65-219 Modular 2 Amp Matrix, available in sizes up to 60x40

Connectivity Solutions

We provide a full range of supporting cable and connector solutions for all our switching products—20 connector families with 1200+ products. We offer everything from simple mating connectors to complex cables assemblies and terminal blocks. All assemblies are manufactured by Pickering and are guaranteed to mechanically and electrically mate to our modules.

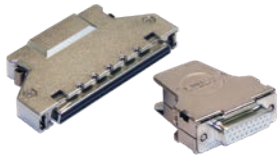

Connectors & Backshells



Multiway Cable Assemblies

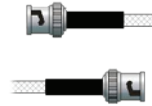

RF Cable Assemblies



Connector Blocks

We also offer customized cabling and have a free online **Cable Design Tool** that can be used to create custom cable solutions for many applications. Visit: pickeringtest.com/cdt to start your design.

Mass Interconnect

We recommend the use of a mass interconnect solution when an Interchangeable Test Adapter (ITA) is required for a PXI or LXI based test system. Our modules are fully supported by both Virginia Panel and MacPanel.

Pickering Reed Relays

We are the only switch provider with in-house reed relay manufacturing capability via our Relay Division. These instrument grade reed relays feature **SoftCenter™** technology, ensuring long service life and repeatable contact performance. To learn more, please go to: pickeringrelay.com



Programming

Pickering provide kernel, IVI and VISA (NI & Keysight) drivers which are compatible with all Microsoft supported versions of Windows and popular older versions. For a list of all supporting operating systems, please see: pickeringtest.com/os

The VISA driver support is provided for LabVIEW Real Time Operating Systems (Pharlap and Linux-RT). For other RTOS support contact Pickering. These drivers may be used with a variety of programming environments and applications including:

- **Pickering Interfaces Switch Path Manager**
- **National Instruments** products (LabVIEW, LabWindows/CVI, Switch Executive, MAX, TestStand, VeriStand, etc.)
- **Microsoft Visual Studio** products (Visual Basic, Visual C++)
- **Programming Languages** C, C++, C#, Python
- **Keysight** VEE and OpenTAP
- **Mathworks** Matlab
- **Marvin** ATEasy
- **MTQ Testsolutions** Tecap Test & Measurement Suite

As well as various open source environments such as:

- **Sharp Develop**
- **Dev-C++**

To learn more about software drivers and development environments, please go to: pickeringtest.com/software

Signal Routing Software

Our signal routing software, Switch Path Manager, automatically selects and energizes switch paths through Pickering switching systems. Signal routing is performed by simply defining test system endpoints to be connected together, greatly accelerating Test System software development. To learn more, please go to: pickeringtest.com/spm

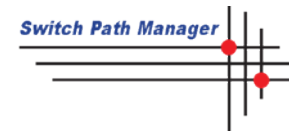

Diagnostic Relay Test Tools

eBIRST Switching System Test Tools are designed specifically for our PXI, PCI or LXI products, these tools simplify switching system fault-finding by quickly testing the system and graphically identifying the faulty relay. To learn more, please go to: pickeringtest.com/ebirst



Three Year Warranty & Guaranteed Long-Term Support

All standard products manufactured by Pickering Interfaces are warranted against defective materials and workmanship for a period of three years from the date of delivery to the original purchaser. Extended warranty and service agreements are available for all our modules and systems with various levels to suit your requirements. Although we offer a 3-year warranty as standard, we also include guaranteed long-term support—with a history of supporting our products for typically 15-20 years. To learn more, please go to: pickeringtest.com/support

Available Product Resources

We have a large library of product resources including success stories, product and support videos, articles and white papers as well as application specific product brochures to assist when looking for the switching, simulation and connection solutions you need. We have also published handy reference books on Switching Technology and for the PXI and LXI standards.



To view, download or request any of our product resources, please visit: pickeringtest.com/resources

© Copyright (2023) Pickering Interfaces. All Rights Reserved. Pickering Interfaces maintains a commitment to continuous product development, consequently we reserve the right to vary from the description given in this data sheet.